

KOMUNIKACE A DROBNÝ STAVEBNÍ MATERIÁL

2.1 DLAŽBA

2.1.12 Šestiboká dlažba HEXO®

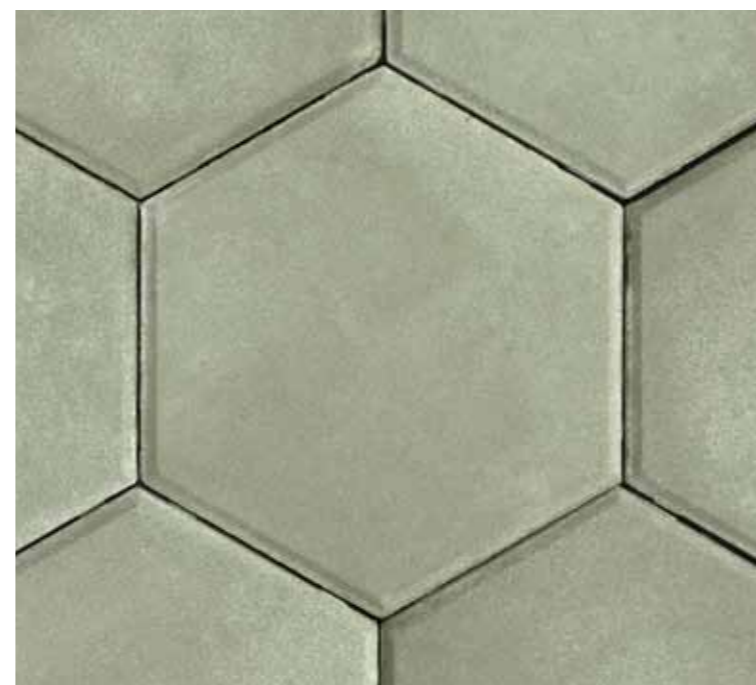
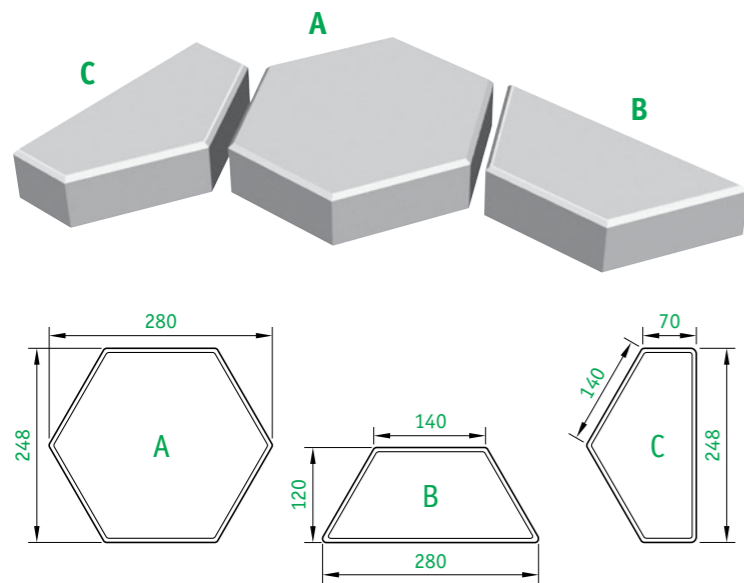

název	značka	sklad. rozměry [mm]			ks/m ²	m ² na paletě	výrobní závod	barevné provedení		
		L	B	H				zákl.	lux	melír
šestiboká dlažba HEXO®										
Hexo® A	HEX 28/25/6	282	250	60	18,8	6,97	Božice	✓	✓	
Hexo® B	HEX 28/12/6	282	122	60	15,0	7,79	Božice	✓	✓	
Hexo® C	HEX 25/14/6	250	140	60	23,0					

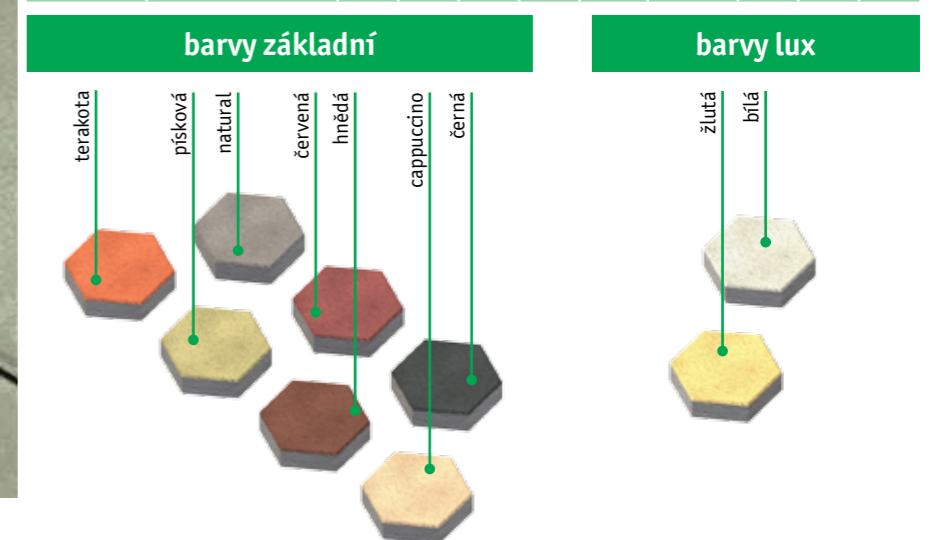

KOMUNIKACE A DROBNÝ STAVEBNÍ MATERIÁL

2.1 DLAŽBA

2.1.13 Pravoúhlá dlažba HBG®

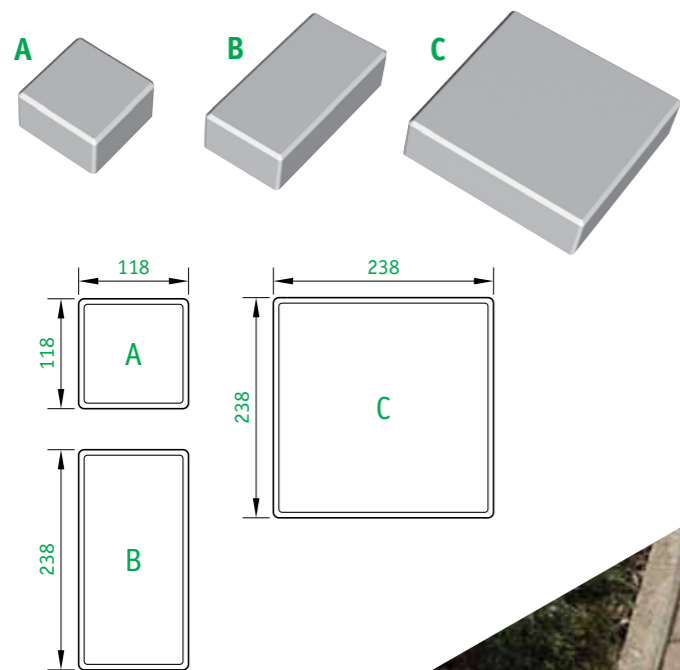

2.1.14 Chodníková dlažba HBG®

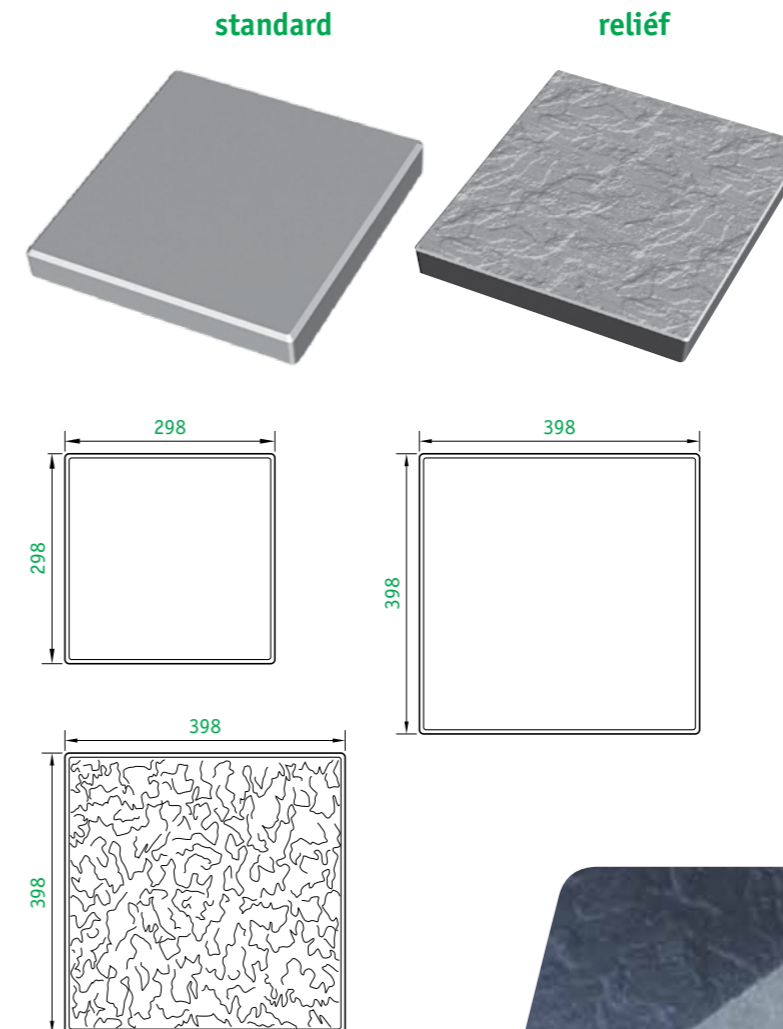

název	značka	sklad. rozměry [mm]			ks/m ²	m ² na paletě	výrobní závod	barevné provedení		
		L	B	H				zákl.	lux	melír
pravoúhlá dlažba HBG®										
kostka A	HBG 12/12/4,5	120	120	45	69,4	12,19	Božice	✓		
pásek B	HBG 24/12/4,5	240	120	45	34,7	12,19	Božice	✓		
čtverec C	HBG 24/24/4,5	240	240	45	17,4	10,37	Božice	✓		
kostka A	HBG 12/12/6	120	120	60	69,4	10,08	Božice	✓		
pásek B	HBG 24/12/6	240	120	60	34,7	10,08	Božice	✓		
čtverec C	HBG 24/24/6	240	240	60	17,4	8,64	Božice	✓		

Poznámka: Výroba pouze nad 100 m².

barvy základní

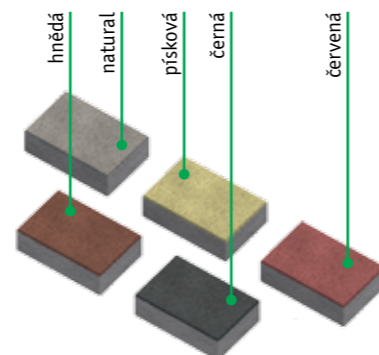

barvy základní

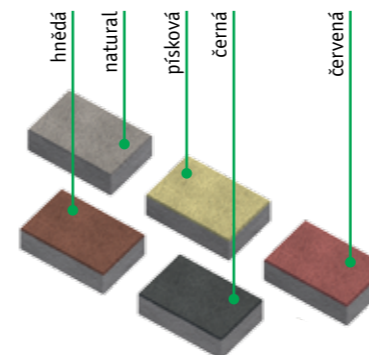

název	značka	sklad. rozměry [mm]			ks/m ²	m ² na paletě	výrobní závod	barevné provedení		
		L	B	H				zákl.	lux	melír
chodníková dlažba 30/30										
standard	HBG 30/30/5	300	300	50	11,1	10,2	Oslavany	✓		
chodníková dlažba 40/40										
standard	HBG 40/40/5	400	400	50	6,3	10,56	Oslavany	✓		
relief	HBG 40/40/5	400	400	50	6,3	10,56	Oslavany	✓		